

Pump Hydroswim HPS

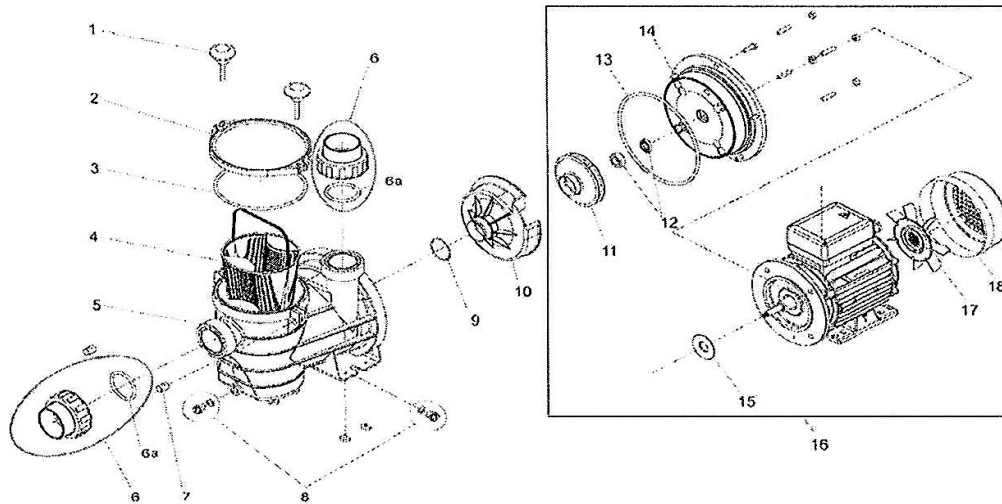

Ref LMP	Item	Description	Manuf Code	Retail Price
HYPHP01	1	Hand Knob HGS / HPS	NYM100134	8,05
HYPHP02	2+3	Strainer Cover HPS + gasket	10002597	42,14
HYPHP03	3	Strainer Cover gasket HP/HK	10002599pce	3,52
HYPHP04	4	Strainer basket HP/HK	NYM100130	9,43
HYPHP05	5+8	Pump Housing HPS blue	NYM100140SBEpce	84,27
HYPHP06A	6a	Union gasket HP	10002600pce	1,38
HYPHP06B	6+6a	Kit raccord à coller 2»1/4x50	HP08025C006	12,58
HYPHP06C	6+6a	Kit raccord taraudé 1»1/2	THP11/2	25,16
HYPHP07	7	Insert laiton HPS/HGS	NYM200002	6,29
HYPHP08	8	Drain plug with gasket HP HG	10002577pce	44,02
HYPHP09	9	Diffuser gasket HP HG	10002576pce	6,67
HYPHP10	10	Diffuser HP	NYM100123	8,93
HYPHP11A	11	Impeller 100 x 6 - HP025/033	NYM55555283	31,45
HYPHP11B	11	Impeller 103 x 6 - HP050	NYM55555223	31,45
HYPHP11C	11	Impeller 108 x 6 - HP075	NYM55555227	31,45
HYPHP11D	11	Impeller 114 x 6 - HP100	NYM55555284	31,45
HYPHP11E	11	Impeller 120 x 6 - HP150	NYM55555285	31,45
HYPHP12A	12	Mechanical seal assembly	NYM400001	16,98
HYPHP12B	12	Mechanical seal assembly (sea water)	NYM400003	23,27
HYPHP13	13	Housing gasket HP	10002601pce	4,40
HYPHP14A	14	Seal Plate HP025 à HP075	NYM10012463	47,80
HYPHP14B	14	Seal Plate HP100/150	NYM10012471	47,80
HYPHP15	15	Joint casse goutte HP/HG	10002583pce	4,03
HYPHP17A	17	Fan HP33/50/75	10002566	3,14
HYPHP17B	17	Fan HP100/150 et HG050 à HG200	10002567	4,00
HYPHP18A	18	Cover Fan HP025 à HP075	NYM55555267	23,90
HYPHP18B	18	Cover Fan HP100/150	NYM55555202	24,53
HYPHP19A		Condensator HP33/50/75 et HKV033/50/75	10002553	22,64
HYPHP19B		Condensator HP100/150 et HG050 à HG100	10002555	24,53
HYPHP20A		Roulement front HP33/50/75 et HK	10002564	nc
HYPHP20B		Roulement rear HP33/50/75 et HK	10002565	nc
HYPHP20C		Roulement front HP100/150 et HG050 à HG200	10002561	42,77
HYPHP20D		Roulement rear HP100/150 et HG050 à HG200	10002560	37,74

Pump Hydrosxim HGS

Ref LMP	Item	Description	Manuf Code	Retail Price
HYPHP01	1	Hand Knob HGS / HPS	NYM100134	8,05
HYPHG02	2	Strainer Cover HGS (PHMB) + gasket	10002572	45,28
HYPHG03	3	Strainer Cover gasket HG	10002574pce	4,28
HYPHG04	4	Strainer basket HG	NYM100115	15,09
HYPHG05A	5+8	Pump Housing HGS black	NYM100104SNE	104,40
HYPHG05B	5+8	Pump Housing HGS blue	NYM100104SBE	104,40
HYPHG06A	6a	Union gasket HG	10002575pce	2,01
HYPHG06B	6+6a	Kit raccord à coller 2»3/4x50 - HG50 à HG100	HG10050C006	16,35
HYPHG06C	6+6a	Kit raccord à coller 2»3/4x63 - HG 150 à HG400	HG08150C006	16,35
HYPHP07	7	Insert laiton HPS/HGS	NYM200002	6,29
HYPHP08	8	Drain plug with gasket HP HG	10002577pce	44,02
HYPHP09	9	Diffuser gasket HP HG	10002576pce	6,67
HYPHG10	10	Diffuser HG	NYM100105	12,58
HYPHG11A	11	Impeller 99 x 9 - HG050	NYM55555255	31,45
HYPHG11B	11	Impeller 104 x 9 - HG075	NYM55555256	31,45
HYPHG11C	11	Impeller 108 x 9 - HG100	NYM55555281	31,45
HYPHG11D	11	Impeller 116 x 9 - HG150	NYM55555257	31,45
HYPHG11E	11	Impeller 117,5 x 9 - HG200	NYM55555277	31,45
HYPHG11F	11	Impeller 120 x 13,5 - HG250 et HG300M	NYM55555282	31,45
HYPHG11G	11	Impeller 125 x 13,5 - HG300T et HG400	NYM55555286	31,45
HYPHP12B	12	Mechanical seal assembly (sea water)	NYM400003	23,27
HYPHG13	13	Housing gasket HG	10002571pce	4,83
HYPHG14A	14	Seal Plate HG050 à HG200	NYM100106	56,10
HYPHG14B	14	Seal Plate HG250 à HG400	NYM10010680	56,10
HYPHP15	15	Joint casse goutte HP/HG	10002583	20,13
HYPHP17B	17	Fan HP100/150 et HG050 à HG200	10002567	4,00
HYPHG17A	17	Fan HG250 à HG300	10002568	5,35
HYPHG17B	17	Fan HG400	10002569	7,17
HYPHP18B	18	Cover Fan HP100/150 & HG050 à HG200	NYM55555202	24,53
HYPHG18	18	Cover Fan HG250 et HG300	NYM55555204	25,16
HYPHP19B		Condensator HP100/150 et HG050 à HG100	10002555	24,02
HYPHG19A		Condensator pour HG150	10002556	33,33
HYPHG19B		Condensator pour HG200	10002557	38,99
HYPHG19C		Condensator pour HG250 à HG300	10002558	40,25
HYPHG19D		Condensator pour HG400	10002559	57,86
HYPHP20D		Roulement rear HP100/150 et HG050 à HG200	10002560	42,01
HYPHP20C		Roulement front HP100/150 et HG050 à HG200	10002561	50,88
HYPHG20A		Roulement avant et arrière pour HG250 à HG300	10002562	52,20
HYPHG20B		Roulement avant et arrière pour HG400	10002563	nc

Pump Basket

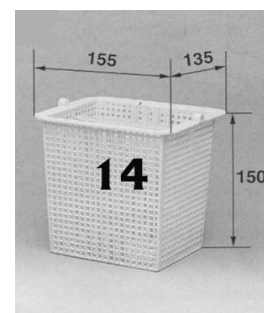
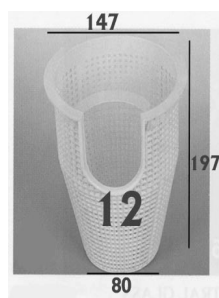
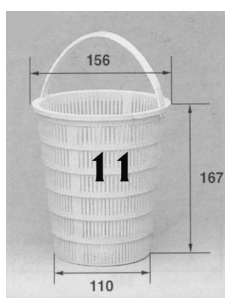
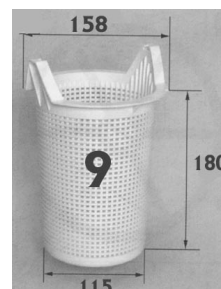
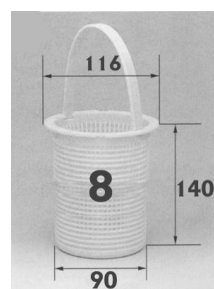
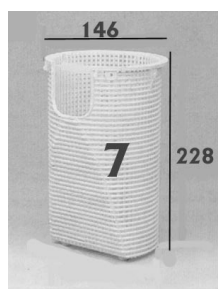
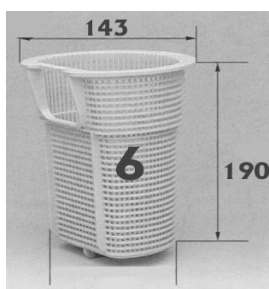
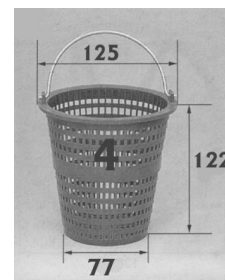
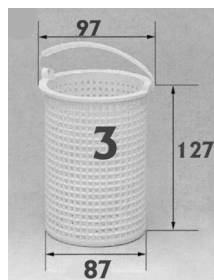
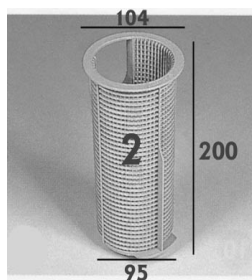
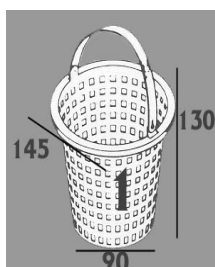

Item n°	Manuf. Code	Description	Retail price
1	No ref.	Pompe Purex Bronze	nc
2	HAPMF05B	Pompe Hayward S1800/S2800	10,29
3	HAPMF05A	Pompe Hayward S1800	7,81
4	No Ref.	Pompe Pahlens 50-150	nc
6	HAPPF03B	Pompe Hayward Pow.Flo N.MOD	13,71
7	HAPSP05	Pompe Hayward S3000	13,71
8	PESPS05	Pompe Espa FL.NS.	15,1
9	PESPT04	Pompe Espa FL.2NS	nc
11	PLPGD09	Pompe Pahlens 200-550	52,66
12	No Ref.	Pompe Purex Aquatron	nc
13	No Ref.	Pompe Sta-Rite DH6	nc
14	HAPNY05	Pompe Hayward S1600/2600	5,03